

ATTENTION

Read carefully these instructions before installing and using this device and keep them for future reference. Attention to installation and electrical wiring. Use this device only as described in this document and never use itself as a security device. The device must be disposed of in accordance with local standards for the collection of electrical and electronic equipment.



DESCRIPTION

The device is wall mounted. Model WM_RC. It performs 2 functions. As Remote Control and as room thermostat of **MACON_C2**, **MACON_HP** and **MACON_HPR** devices. It can work in 2 ways:

1st. Remote Control only. It continuously displays the MACON screen and the keyboard controls the MACON device.

For this function we place the JUMPER as shown in figure 1.

2nd. Remote Control and Room Thermostat. It continuously displays the room temperature and the buttons control the room thermostat. By pressing the button

SET+ for 1 sec changes to **Remote Control** mode, displays the MACON screen, the keyboard operates the MACON and lights the **RC** LED (remote control). If no button is pressed for 20 seconds, it automatically switches to room thermostat mode. Of course, the device constantly communicates with the MACON and in case it loses communication, it outputs a **n C** message and the buzzer is activated. Also, if an **ALARM** appears in MACON, the buzzer activated and **ALARM ALC** is displayed. For the Remote Control / Room Thermostat function, the JUMPER must come out of the 2 pins.

The room temperature is controlled with a NTC or PTC type sensor and the device has a 10A 250VAC relay. It has an input for direct connection via Modbus RS485, with MACON devices. It has 3 temperature display digits with an accuracy of 0.5°C and 4 keys. The device is wall mounted and is screwed onto the wall.

REMOTE CONTROL MACON - INDICATIONS

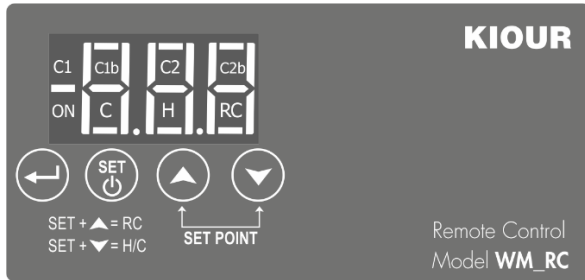

What the LEDs mean in connected mode MACON_C2	
C1	1 st compressor operation on 1st circuit
C2	2 nd compressor operation on 2nd circuit
ON	MACON ON/OFF status.
C	cooling function
H	heating function
RC	display screen of Remote Control when communicating with MACON

What the LEDs mean in connected mode MACON_HP ñ HPR	
C1	operation of 1 st compressor on 1 st circuit
C1b	operation of 2 nd compressor on 1 st circuit
C2	operation of 1 st compressor on 2 nd circuit
C2b	operation of 2 nd compressor on 2 nd circuit
ON	MACON ON/OFF status when working as a remote control
C	cooling mode
H	heating mode
RC	display screen of Remote Control when communicating with MACON

What the LEDs mean in operation: Room Thermostat	
ON	relay operating status 10A 250VAC.
C	cooling mode
H	heating mode

BUTTONS FUNCTIONS

Keyboard	
	Entry/exit to the parameters menu in RT and RC mode (Room Thermostat and Remote Control)
	1) Parameter value display. Registering a new parameter in RT and RC mode 2) By pressing for 5 sec switch ON-OFF. SET+ =RC. SET+ = H/C
	1.Up arrow in RT and RC mode. 2. SET+ =RC
	1.Down arrow in RT and RC mode. 2. SET+ = H/C

For more indications on the screen concerning device alarms see page 3.

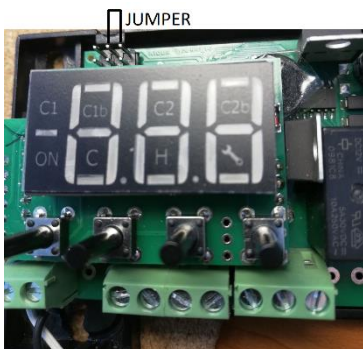





The device can function as a room thermostat and as a MACON remote control or exclusively as a MACON remote control







With the jumper placed on the 2 boards on the top right as shown in the picture, the device works exclusively as a Remote Control.

Without the jumper it works as a remote control and room thermostat.

ADJUSTING THERMOSTAT TEMPERATURE – SET POINT

1. Press  and the **SPC** parameter is displayed.
2. Press  its value is displayed and with  or  we change the **SPC**.
3. Press  we enter the new value and the device works normally with the new setting.

INDUSTRIAL FACTORY SETTINGS

1. Press  to display the first parameter **SPC**. Press two times  and the parameter **Cod** is displayed
2. Press  to display its value and press  to enter the value **31**. Press  to store the value to parameter **Cod**.
3. Press  again to exit the parameter menu all appropriate factory settings are now stored in the device.

SWITCHING HEAT-COOL MODE









On the room thermostat, pressing for 1 seconds **SET+** , switches the mode from HEAT to COOL and opposite.

ON/OFF DEVICE

To activate or deactivate the device, press for 5 seconds  It displays **OFF**.

PROGRAMMING PARAMETERS

ATTENTION : to gain full access to the parameter's menu, the 3rd parameter **Cod** must be adjusted to **22** (see parameter table at next page).

1. Press  to enter the parameter menu.
2. Choose the parameter you want to adjust by pressing  or  and press  to display it's value.
3. Press  or  to change its value and then press  to store the new value.
4. Press  to exit the parameter menu.

TECHNICAL SPECIFICATIONS

Power supply: 12÷24VAC/DC / Maximum power consumption: 3W.

It is recommended using a power supply safety fuse: 0.5A (not included)

Room temperature sensor NTC 10K 1% 25°C with temperature range -50÷+112°C (-58÷+230°F) IP68 (or PTC 1K 25°C temperature range -50÷+150°C (-58÷+302°F) not included) / Accuracy: 0.5°C

Input modbus RS485

Relay 10A res. 250VAC **NO** -normally open- contact / Max current load 10A

Connections with terminal blocks 18A using cable with cable cross section up to 2.5 mm² / It is recommended using a torque wrench with maximum torque 0.4Nm

Operating temperature: -15÷+55°C / Storage temperature: -20÷+80°C

Dimensions 121x70x35mm / The device is wall mounted and is screwed to the wall with 2 screws / Protection IP20

Firmware: V1.2

ELECTRICAL DIAGRAM - DIMENSIONS

ATTENTION: according to safety standards, the device must be properly positioned and protected from any contact with electrical parts. The device must be fastened in such a way that it cannot be removed without the use of tools. Disconnect the main safety switch of the installation before proceeding to any maintenance. Disconnect the power supply of the device before proceeding to any maintenance. Do not place the device near heat sources, equipment containing strong magnets, in areas affected by direct sunlight or rain. Prevent electrostatic discharges and sharp objects from been inserted to the device. Separate signal cables from power supply cables to prevent electromagnetic disorders. Signal cables must never be in the same pipe with the power supply cables. **ATTENTION**: Read carefully the technical specifications and make sure that the working conditions are appropriate. According to safety standards, the device must be fastened in such a way that it cannot be removed without the use of tools.

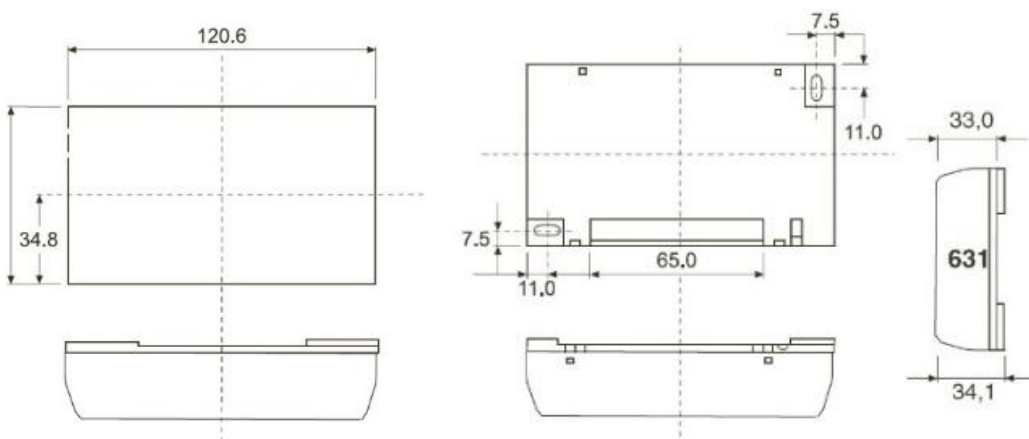

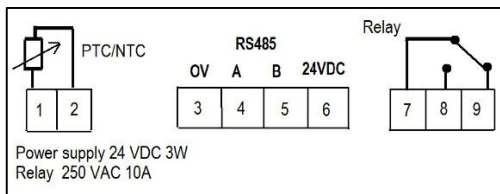

CONNECTION Remote Control with MACON

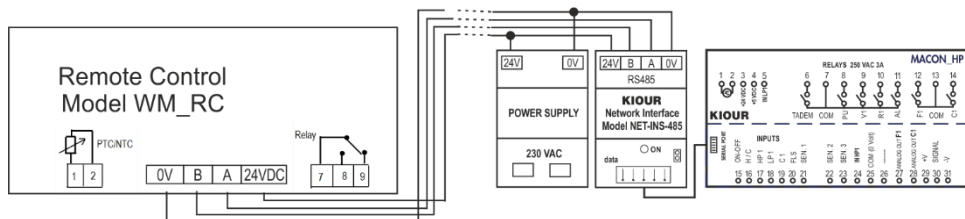

TABLE OF ROOM THERMOSTAT PARAMETERS

#		description	min	max	WMRCC2 WMRCHP	UOM
1	SPC	SET POINT in cooling	20.0	30.0	25.0	°C
2	SPH	SET POINT in heating	17.0	30.0	20.0	°C
3	Cod	Enter the code Cod = 22 and press to enter the other parameters	0	255	0	-
4	diC	Cooling - Heating differential	0.1	25.0	3.0	°C
5	SE1	Room sensor offset	-9.9	10.0	0	°C
6	SEN	Sensor type 0 = PTC / 1 = NTC	0	1	0 = PTC	-

ROOM THERMOSTAT ALARM TABLE

1	LF1	Room sensor malfunction
2	n C	communication failure with MACON
3	EEr	Error in memory RAM: re-enter the SPo (see ADJUSTING TEMPERATURE – SET POINT previous 1)

The alarms are automatically deactivated once the cause of the alarm disappears.

ALARM TABLE MACON

1	ALC	There is a malfunction in MACON device
2	n C	No communication with MACON device

The alarms are automatically deactivated once the cause of the alarm disappears.

Version V1.2 // 14-12-2023. . Changed keyboard handling. 1. With the up and down arrows, the corresponding SET POINT of cooling or heating that the instrument is set to is directly changed and the corresponding LED flashes. 2. With SET + turns the keyboard and screen to MACON operation and display. 3. With SET + control H/C. 4. With SET ON-OFF the device.

Version V1.1// 12-7-2022. 1^{ov} . ON-OFF and H/C device status is coordinated with MACON_C2 device. The thermostat intervenes in the MACON depending on the setting of the MACON. It is possible that when the thermostat gives the OFF command, it stops the operation of the compressors.

Made in Greece



The device is under two year's guarantee. The guarantee is valid only if the manual instructions have been applied. The control and service of the device must be done by an authorized technician. The guarantee covers only the replacement or the service of the device. KIOUR PC implements a Quality Management System according to EN ISO 9001:2015 Standard with registration number 01013192. KIOUR preserves the right to adjust its products without further notice.