

ATTENTION

Read carefully these instructions before installing and using this device and keep them for future reference. Attention to installation and electrical wiring. Use this device only as described in this document and never use itself as a security device. The device must be disposed of in accordance with local standards for the collection of electrical and electronic equipment.



DESCRIPTION

FA5R is a temperature controller for ventilated freezer rooms with deFrost control and smart defrost function. It has two temperature sensors for the cabinet and the evaporator, five relays: compressor 30A, fan 5A, deFrost 10A, lamp 5A, and auxiliary/alarm 10A; one alarm buzzer and three digital inputs for controlling the door of the room (DOOR indication), for the protection of a person inside the room (indication MAN) and for the compressor's presostat signal. Both sensors can be either NTC or PTC by adjusting a parameter. The controller via the serial input can connect either via mobile application to CORTEX cloud platform or via pc to the CAMIN Modbus network for full monitoring and data logging of the device.

INDICATIONS AND BUTTONS FUNCTION

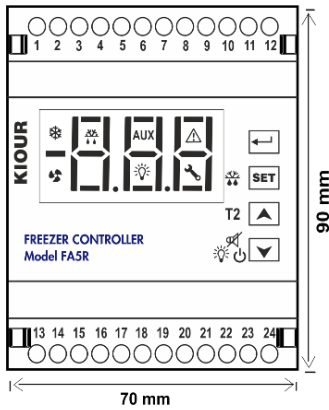

Display indications	
	compressor ON
	fan ON
	defrost ON
AUX	aux relay ON
	lamp ON
	alarm ON
	malfunction ON

Keyboard	
	enter the parameter's menu
	display the parameter's value enter parameter's value manual defrost
	up arrow display evaporator temperature T2
	down arrow mute buzzer lamp is on/ off (check below) ON/OFF device (check below)

For more indications regarding the alarms please see at page 5

ADJUSTING TEMPERATURE – SET POINT

1. Press to display the first parameter **SPo**.
2. Press to display its value and with the or we change **SPo** value.
3. Press to save the new value. The device is working with the new adjustment.

INDUSTRIAL FACTORY SETTINGS

1. Press to display **SPo**. Press and the parameter **Cod** is displayed.
2. Press to display its value and press to enter the value **31**. Press to store the value to parameter **Cod**.
3. Press again to exit the parameter menu. 'YES' is displayed on the screen. All appropriate factory settings are now stored in the device.

ON/OFF DEVICE

To activate or deactivate the device, press for 7 seconds .

ON/OFF LAMP

If we select the *manual* operation of the room lamp, dLA = 0, then to turn it on or off, press for 3 seconds .

If we select the *automatic* operation of the room lamp, dLA = 1, then the lamp opens and closes based on the room door switch. By setting a desired time in the tLA parameter, when the room door closes, the lamp stays on for tLA time and then turns off automatically.

MANUAL DEFROST









Press for 3 seconds to start a manual defrost with duration based on the parameter **dd2**.
For more information regarding the defrost, check the description of parameter **dt6**.

SOS ALARM - MAN INSIDE THE ROOM

From parameter 22, EnP = 1, we activate the digital input for the use of a button inside the room, in order to protect a person locked inside the room. In contacts 8 and 11 (MAN contact) we connect a button with NC contact. When the button is pressed, all functions and alarms are deactivated and the lamp relay is activated. The 'SOS' alarm appears on display. The button must reset to restart the thermostat. The lamp goes out manually.

PROGRAMMING A PARAMETER

ATTENTION: to gain full access to the parameter's menu, the 2nd parameter **Cod** must be adjusted to **22** (see parameter table page 2).

1. Press  to enter the parameter menu.
2. Choose the parameter you want to adjust by pressing  or  and press  to display its value.
3. Press  or  to change its value and then press  to store the new value.
4. Press  to exit the parameter menu.

TECHNICAL SPECIFICATIONS

Model **FA5R** power supply: 230VAC 50/60Hz / Maximum power consumption: 3W. Model **FA5RW** switching power supply: 100-264VAC 50/60Hz 5W

It is recommended using a power supply safety fuse: 0.5A (not included)

Room and evaporator temperature sensors NTC 10K 1% 25°C IP68 scale -50÷+110°C (-58÷+230°F) (or PTC 1K 25°C scale -50÷+150°C (-58÷+302°F) not included) / Accuracy: ±0.5°C

Alarm buzzer / Serial input

Three digital inputs: one NO / NC for room door control (DOOR indication), one NC contact for in-room human protection (MAN indication) and one NO/NC contact for compressor's presostat input

Compressor relay 30A res. 250VAC NO contact / Fan and lamp relays NO contact 250VAC 5A / Defrost relay NO contact 250VAC 10A

Relay AUX SPDT 250VAC NO contact 10A and NC contact 3A / Max current load 16A

Connections: cable cross section 2.5 mm² for all relays / cable cross section from 0.25 to 1.0 mm² for the sensors and door switch

Connections with terminal blocks 18A using cable with cable cross section up to 2.5 mm² / It is recommended using a torque wrench with maximum torque 0.4Nm

Operating temperature: -15÷+55°C / Storage temperature: -20÷+80°C

The device is mounted on Ω rail / Dimensions 70x90x65mm

Firmware: V3.1.0

SERIAL INPUT

FA5R connects via serial input to the following options:

- Mobile application for android and iOS, Cloud service and CORTEX platform: connection to the cloud and the CORTEX platform for monitoring - recording and managing the thermostat from your mobile, tablet or any computer, email and mobile notifications in case of an alarm.
- CAMIN program: local connection and monitoring - recording and management of the thermostat through the CAMIN program installed on a local computer.

SMART DEFROST

Smart defrost operation: the thermostat finds automatically the ideal operating temperature of the evaporator. If the evaporator operates at a temperature lower than the constant temperature based on dSt parameter and for a time longer than the constant timer dS1 parameter, defrosting begins.

Smart defrost operates in parallel and independently from the conventional defrost. Both defrost modes can operate at the same time based on the respective settings. By enabling smart defrost, it is recommended to adjust conventional defrost to operate in safe mode - for example once every 48 hours: parameter No 22, dFr = 48. If smart defrost is not executed, then the conventional defrost will start after 48 hours from the last successful defrost. Each time a smart defrost is executed, the timer of the conventional defrost is renewed.

Smart defrost is activated from parameter No 29, dSE = 1.

It is recommended during the start-up of the temperature controller, to execute a smart defrost cycle, parameter No 30, dSb = 1.

Constants time dS1 and temperature dSt are formed based on the ice status of the evaporator: if we observe ice, we reduce the constants.

ELECTRICAL DIAGRAM - DIMENSIONS



ATTENTION: according to safety standards, the device must be properly positioned and protected from any contact with electrical parts. The device must be fastened in such a way that it cannot be removed without the use of tools. Disconnect the main safety switch of the installation before proceeding to any maintenance. Disconnect the power supply of the device before proceeding to any maintenance. Do not place the device near heat sources, equipment containing strong magnets, in areas affected by direct sunlight or rain. Prevent electrostatic discharges and sharp objects from being inserted to the device. Separate signal cables from power supply cables to prevent electromagnetic disorders. Signal cables must never be in the same pipe with the power supply cables.

ATTENTION: Read carefully the technical specifications and make sure that the working conditions are appropriate. According to safety standards, the device must be fastened in such a way that it cannot be removed without the use of tools.

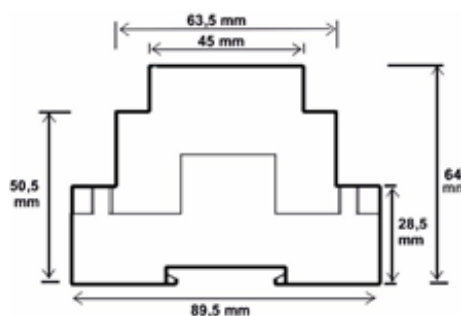
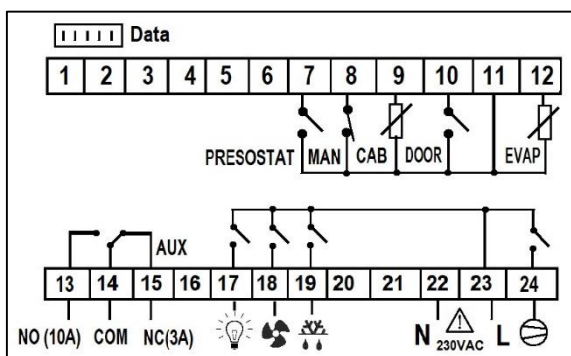
Dimensions are in mm. The device is mounted on Ω rail din and restrained with plastic side bracket.



PARAMETER'S TABLE

No		description	min	max	FA5R	UOM
1	SPo	SET POINT: room temperature setting	LSP	HSP	-21.0	°C/°F
2	Cod	Enter password Cod = 22 and press  to access all parameters menu	0	255	0	-
ANALOG INPUTS - TEMPERATURE						
3	dIF	Differential of room temperature SPo (thermostat delay)	0.1	25.5	3.0	°C/°F
4	LSP	Lower setting limit of SPo	-50.0	+150	-21.0	°C/°F
5	HSP	Maximum setting limit of SPo	-50.0	+150	-10.0	°C/°F
6	dEC	Temperature indication as integer or decimal, where 0 = integer / 1 = decimal	0	1	1 = decimal	-
7	SEn	Sensor type NTC/PTC 0 = PTC / 1 = NTC	0	1	1=NTC	-
8	SE1	Room sensor offset	-10.0	+10.0	0.0	°C/°F
9	SE2	Evaporator sensor offset	-10.0	+10.0	0.0	°C/°F
10	tdS	Delay in displaying the actual room temperature on the screen when the door opens	0	255	0	minutes
11	oS2	Evaporator's sensor operation 0 = OFF sensor 1 = ON sensor When the sensor is OFF, by pressing  it is displayed "----". During defrosting, when the evaporator sensor is off, the defrost end temperature is the room temperature.	0	1	1= ON	-
12	C_F	Temperature measurement unit: toggling between °C/°F does not adjust the SPo automatically, it must be changed by the user : 0 = °C / 1 = °F	0	1	0=°C	°C/°F
ALARMS						
13	ALo	Low room temperature	-50.0	+150	-25.0	°C/°F
14	AHi	High room temperature	-50.0	+150	0.0	°C/°F
15	At2	Time delay in activating "AHi", "ALo" and the buzzer among them. This setting does not apply to sensor failure and door alarm. -1 = OFF buzzer 0 = immediately buzzer is ON 1 to 120 min = delay in buzzer activation	-01	120	20	minutes
16	AF1	Alarm setting 0 = automatic OFF, where the alarm stops once the cause of the alarm disappears. 1 = manual OFF, where the alarm indication remains even if the cause of the alarm disappears and it's cleared only by pressing  . In any case, by pressing  the buzzer stops and  turns on to state that the cause of the alarm still exists.	0	1	0 = auto	-
DIGITAL INPUT – DOOR SWITCH						
17	dLd	Door switch operation 0=OFF 1=NC (normally close contact) 2=NO (normally open contact) If cabinet's door is open during defrost (electrical or hot-gas) for more than timer tdo, then defrost relay turns OFF and resumes once door is closed. Defrost duration based on timer dd2 stops counting as long as the door is open and resumes once it closes.	0	2	1=ON with NC	-
18	tdo	Time delay in deactivating the compressor once the door opens If the tdo time is longer than the time of the tAd parameter, then the "dor" alarm is activated after a tdo time.	1	250	120	sec
19	tAd	Time delay in activating door alarm "dor" once the door opens If timer tAd is smaller than timer tdo, then the alarm "dor" is activated after timer tdo elapses.	0	250	0	minutes
20	dLA	Adjust lamp function 0 = manual: the lamp turns on - off by holding down  . 1 = automatic: when the room door opens, the lamp turns on and when the door closes, the lamp goes out. When the door switch is OFF, the lamp does not light up.	0	1	1=auto	-
21	tLA	Delay time in switching off the lamp when the door is closed. This setting is activated if the lamp setting is in automatic mode, parameter dLA.	0	60	0	minutes
22	EnP	MAN input switch operation - human protection inside the cabinet 0 = OFF 1 = ON	0	1	0 = OFF	-
23	PrE	Presostat input operation for controlling the compressor during pump-down mode, parameter AU1=4 0 = OFF 1=NC (normally close contact): once the contact opens, compressor's relay is OFF 2=NO (normally open contact): once the contact closes, compressor's relay is OFF	0	2	0 = OFF	-
DEFROST						
24	dt6	Type of defrost 0 = electrical: compressor OFF, resistance ON 1 = hot gas: compressor ON, resistance ON <u>Defrost with the evaporator's temperature sensor ON</u> Automatic or manual defrost ends either with time adjusted from the parameter dd2 or with defrost end temperature dE5, whatever comes first. Automatic or manual defrost does not start if the evaporator temperature is greater than the defrost end temperature dE5. <u>Defrost with the evaporator's temperature sensor OFF</u> Defrost end temperature is the room temperature.	0	1	0 = electrical	-

		Automatic defrost ends either with time adjusted from the parameter dd2, or with defrost end temperature dE5, whatever comes first. Manual defrost starts regardless of the room's temperature and ends after time adjusted in parameter dd2 elapses.				
25	dFr	Time between two successive defrost, where dFr = 0, defrost is deactivated.	0	100	6	hours
26	dd2	Defrost duration (manual and automatic)	1	120	30	minutes
27	dE5	<u>Defrost end temperature</u> <u>With the evaporator's temperature sensor ON</u> Automatic and manual defrosting does not start if the evaporator temperature is higher than the defrost end temperature dE5. In case of malfunction of the evaporator sensor (LF2), the end of defrost temperature is not checked and is completed after the selected time dd2. <u>With the evaporator's temperature sensor OFF</u> The defrost end temperature is the room temperature. Automatic defrosting does not start if the room temperature is higher than the end temperature of dE5. Manual defrosting starts regardless of the room temperature, is of duration dd2 and does not end based on the room temperature.	0.0	100	30.0	°C/°F
28	dP3	Dripping time, where the compressor is OFF after defrost.	0	15	2	minutes
29	dY4	Display indication during defrost -02 = SPo + diF value is displayed when room temperature is greater than SPo + diF -01 = "dFr" is displayed when room temperature is greater than SPo + diF 0 = room temperature is displayed 1 to 40 minutes = "dFr" is displayed from 1 to 40 minutes from the initiation of defrost	-2	40	-1	minutes
30	dt5	Retention time on the display after the end of defrost, "dFr" or "SPo + diF", only when dY4 = -1 or -2. The display "dFr" is also terminated by the condition → room temperature < SPo + diF.	0	150	0	minutes
SMART DEFROST – more details at page 2						
31	dSE	Smart defrost function 0 = OFF 1 = ON	0	1	0 = OFF	-
32	dSb	A defrost cycle is executed once the device starts-up 0 = OFF 1 = ON	0	1	1 = ON	-
33	dS2	Minimum time between two successive smart defrost	40	255	60	minutes
34	dS1	Time constant: a steady increase in the constant, delays more the start of smart defrost and increases the ice on the evaporator	1	20	3	minutes
35	dSt	Temperature constant: a steady increase in the constant, delays more start of the smart defrost and increases the ice on the evaporator	0.5	5.0	1.0	°C/°F
COMPRESSOR						
36	Co1	Compressor's minimum time ON If parameter AU1= 3 or 4, timer refers to AUX relay. Check parameter AU1 No45 for more details.	0	15	0	minutes
37	CP2	Compressor's minimum pause time OFF If parameter AU1= 3 or 4, timer refers to AUX relay. Check parameter AU1 No45 for more details.	0	15	3	minutes
38	CP3	Compressor's minimum pause time OFF - only during pump-down mode with control from presostat input, parameter AU1=4	0	15	0	minutes
39	CF3	Compressor's operation in case of room's sensor malfunction LF1 -1 = compressor OFF 0 = compressor ON while defrost starts based on timer dFr and ends based on timer dd2 or defrost end temperature dE5, whichever comes first. 1 to 15 min = compressor time ON while defrost starts based on timer dFr and ends based on timer dd2 or defrost end temperature dE5, whichever comes first. If parameter AU1= 3 or 4, timer refers to AUX relay. Check parameter AU1 No45 for more details.	-1	15	3	minutes
40	CF4	Compressor time OFF in case of room's sensor malfunction If parameter AU1= 3 or 4, timer refers to AUX relay. Check parameter AU1 No45 for more details.	1	15	3	minutes
FAN						
41	Ft2	Evaporator's fan operation -02 = continuously ON for evaporator's temperature smaller than temperature Fo1 -01 = continuously ON 0 = parallel operation to the compressor 1÷15 min = parallel operation with the compressor and when the compressor is OFF, the fan stops after the selected minutes	-2	15	-1= ON continuously	minutes
42	Fo1	Evaporator's temperature controlling the fan operation during defrost and normal operation (parameter oS2 = 1). If the evaporator's sensor is OFF, the parameter does not operate. For more information check the parameters Ft2 (No 39) and Fd3 (No 41).	-50.0	+100	-2.0	°C/°F
43	Fd3	Evaporator's fan operation during defrost the with evaporator's sensor ON (parameter oS2 = 1) 0 = OFF and after defrost starts with the compressor if the evaporator's temperature is smaller than Fo1 1 = ON when the evaporator's temperature is smaller than Fo1 2 = always ON in both types of defrost (electrical / hot gas) 3 = always ON in both types of defrost (electrical / hot gas), where the controller does not consider evaporator's sensor status, whether it is operating or not (parameter oS2) <u>With the sensor of the evaporator T2 deactivated</u> , the fan of the evaporator is OFF during the defrost and for a time as long as the dripping time (parameter dP3) and starts after a time Fd4. The Fd4 time starts counting as soon as the defrost is over.	0	3	0	-
44	Fd4	Time delay in activating the fan after defrost ends and only if the evaporator's temperature is smaller than temperature Fo1 (check parameter Fd3).	0	60	0	minutes
RELAY AUX / ALARM						
45	AU1	AUX / ALARM relay operation	0	4	0	-

		<p>0 = OFF 1 = ON in case of any alarm - all alarms activate it 2 = ON in parallel with the compressor ----- 3 = pump-down operation for AUX relay: the operation of the compressor's relay switches to the AUX relay, while the compressor relay is constantly activated and the compressor is controlled by an external presostat switch. The thermostat does not control the compressor under any circumstances. To the AUX relay we connect the compressor's magnetic and the defrost is only electric. After 1 minute from the initiation of the defrost, the compressor relay switches off. Compressor's timers (Co1, CP2, CF3, CF4) are referred to compressor's magnetic and AUX relay. ----- 4 = pump-down operation for AUX relay and compressor control based on presostat signal: this operation occurs, only if parameter PrE = 1 or 2 is enabled and input No.7 is connected to a presostat switch. The operation of the compressor's relay switches to the AUX relay, while the compressor relay is controlled by the presostat switch connected to input No.7. To the AUX relay we connect the compressor's magnetic. Compressor's timers (Co1, CP2, CF3, CF4) are referred to compressor's magnetic and AUX relay, while timer CP3 refers to compressor and compressor's relay. Defrost is only electric and defrost resistance is ON only if compressor relay is OFF.</p>				
NETWORK - GENERAL SETTINGS						
46	Add	Device address on network	0	255	1	-
47	trE	Response time of the device on network	5	100	40	msec
48	bAU	<p>Baud rate: 0 = 2400 / 1 = 4800 / 2 = 9600 / 3 = 19200</p> <p>Enter the new value, exit the parameter menu by pressing  and toggle the power supply of the device</p>	0	3	3	-
49	Pro	Cabinet's program (factory settings) is displayed – no access	-	-	31	-
50	tPE	Unique product number – no access	-	-	228	-
51	SrU	<p>Room service - condenser cleaning: after the end of the selected time, the indication "SrU" is displayed and informs that the room needs service. The thermostat continues to operate normally and its functions are not suspended.</p> <p>-01 = disabled function 0 to 150 weeks = remaining time to activate the "SrU" room service update. The countdown starts with the entry of the number. Whenever we enter the parameter, the remaining time until the activation of the "SrU" update is displayed. To deactivate the update enter SrU = -1.</p>	-1	150	-1	weeks
52	UEr	Firmware version – no access	-	-	3.X.X	-

ALARM'S TABLE

1	LF1	Room sensor malfunction
2	LF2	Evaporator sensor malfunction
3	ALo	Low room temperature
4	AHi	High room temperature
5	dor	<p>Open door alarm (when the cabinet's door opens, the fan stops) The alarm is activated after the time tdo expires</p>
6	SOS	<p>Man inside the cabinet alarm, when the button inside the cabinet is pressed, all functions and other alarms are deactivated and the lamp relay is activated. The button must reset to restart the thermostat.</p>
7	SrU	Room service notification: timer has elapsed and the cabinet needs a service (see parameter 49, SrU)
8	EER	Error in memory RAM: re-enter the SPo (see Adjusting temperature – SET POINT page 1)
The alarms are automatically deactivated once the cause of the alarm disappears.		

Made in Greece.



The device is under two year's guarantee. The guarantee is valid only if the manual instructions have been applied. The control and service of the device must be done by an authorized technician. The guarantee covers only the replacement or the service of the device. KIOUR PC implements a Quality Management System according to EN ISO 9001:2015 Standard with registration number 01013192. KIOUR preserves the right to adjust its products without further notice.